

VESTFROST

SOLUTIONS

REFRIGERATORS

MANUAL OF INSTRUCTIONS FOR USE AND INSTALLATION

CONTENTS

1. Before starting the appliance.
2. How to use the appliance.
3. General advice on the use of the appliance.
4. Maintenance.
5. Has the appliance stopped working?
6. Safety.
7. Technical data.
8. Installation.
9. Change of hinge side.

1. BEFORE STARTING THE APPLIANCE

Check that the cabinet is undamaged. Please report any transport damage **immediately** to your dealer. Wash the cabinet and inner lining with a mild unscented detergent and wipe it dry. Do not use abrasive scouring powder, steel wool or similar. Connection to the electricity supply: See head (7) and (8).

2. HOW TO USE THE APPLIANCE

Operating panel: See fig. (1).

1. Lamp.
2. Thermostat knob.
3. Indicator for the connection to the electricity supply (green).

The thermostat knob is adjustable from 0 (stop) to 7 (coldest). Find the position of the thermostat which gives you the desired temperature. Start at position 4.

Defrosting

The evaporator is automatically defrosted. The defrosted water is led to a tray on top of the compressor where it evaporates.

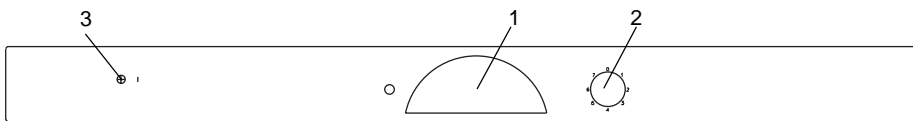

Fig 1.

3. GENERAL ADVICE ON THE USE OF THE APPLIANCE

If the unit is not used for more than two days it should be switched off and the doors should be left open for ventilation to prevent a bad smell in the unit.

The appliance is equipped with a high-quality skin condenser.

Therefore, a slight heating of the sidewalls is quite normal.

Lighting

This appliance is equipped with a device which causes the light to switch off if the door is open / left ajar for abnormally long time.

When the door has been closed for a couple of minutes, the device is cut off and the light switches on in normal way again.

4. MAINTENANCE

Only use an unscented detergent when cleaning the cabinet inside.

Switch off the appliance and pull out the plug when cleaning the cabinet.

The skirting board can be removed to facilitate a vacuum cleaning of the floor. See fig. (1) page 6.

Remember to clean the drain on the back wall of the cabinet.

5. HAS THE APPLIANCE STOPPED WORKING?

Before calling a service engineer, check that the plug is properly plugged into the wall socket.

The fuse is intact.

The power has not been cut off.

All controls are correctly set.

Mounting of lock for one-door uprights

Optional extras.

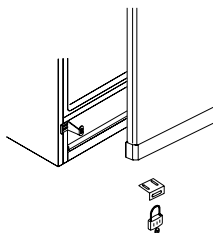

6. SAFETY

Do not store explosive substances in the cabinet, such as gas, cigarette lighters, petrol, ether or similar.

Scrapped cabinets may become dangerous to children at play. Therefore, remove the doors or place the scrapped cabinet in such a way that children cannot enter it.

7. TECHNICAL DATA

This appliance meets the provisions of the following directives: 89/336/EEC (electromagnetic compatibility), 73/23/EEC (electrical equipment designed for use within certain voltage limits) as amended. The rating plate, which is placed either at the back or inside the appliance, see fig. (2), provides various technical information as well as type and serial number.

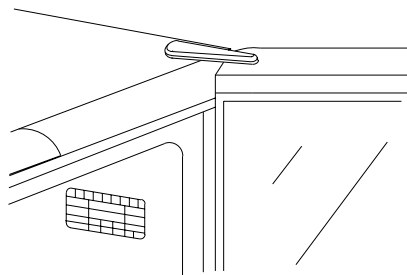

Fig 2.

8. INSTALLATION

See drawings page 6 and 7.

Install the cabinet in a dry place and so that it is not exposed to direct sunlight or any other source of heat.

Place the cabinet in a level position. This is easily achieved by adjusting the adjustable feet at the front edge of the base. The cabinet should not rest against a wall on its hinged side. When placing the cabinet on a carpet or on a wooden floor you should adjust it once more after some time as the cabinet might settle in soft foundations.

The cabinets can be built in or put side by side, see page 7.

For sufficient airflow around the cabinet it is necessary to have a 50mm high air duct right above the appliance, see fig. (1) .

Make sufficient space for door opening to allow the shelves to slide out, see fig. (3).

The dimensions for building in are noted on the drawings.

It is safest to place the earthed wall socket above the appliance and at least 2 m above the floor.

Any local installation rules for appliances of this kind must be observed.

During a storm the electricity supply might be cut off.

You should be aware of this when installing the appliance in weekend cottages or elsewhere where you would not immediately observe that the power has been cut off.

Construction and details in the accessories are subject to alteration without previous notice.

Adjust the tilt of the unit
by turning the adjustable feet with
a spanner.

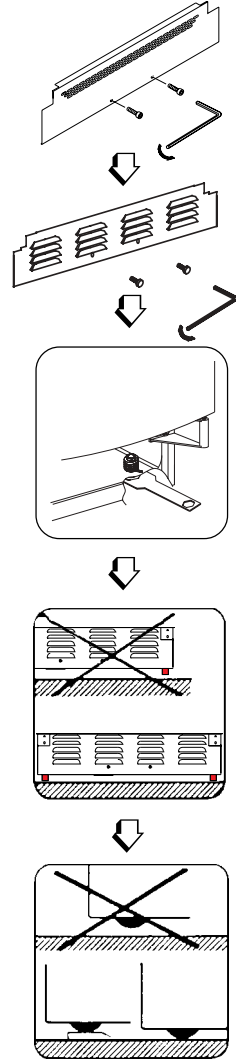
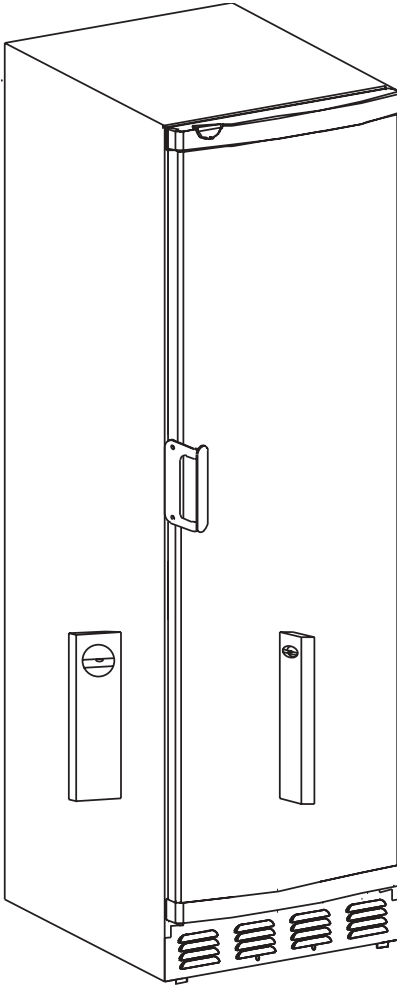

Fig. 1

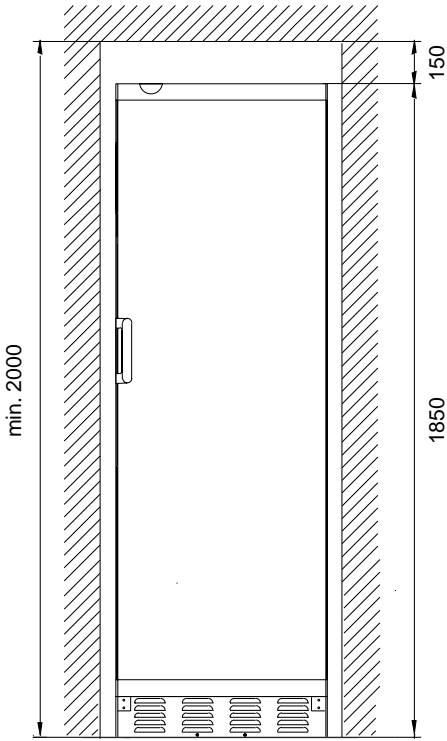
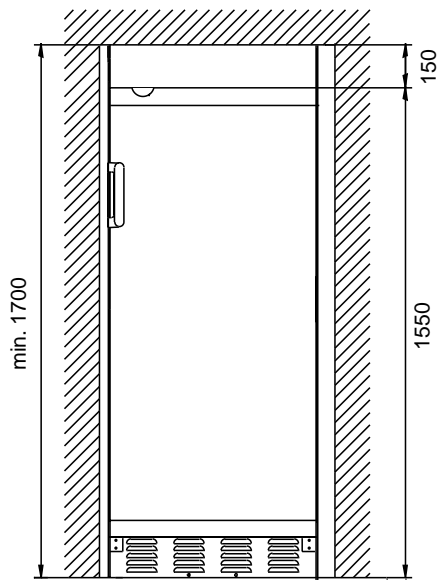

Fig. 2 CFKS 471
CVKS 671



CFKS 411
CVKS 611

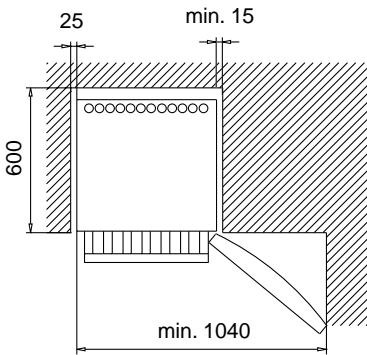

Fig. 3

25 mm

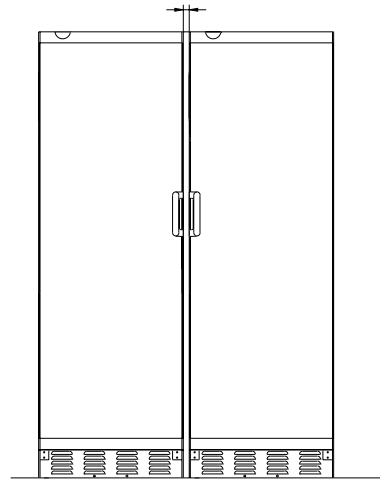
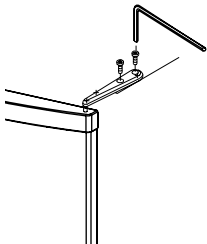

Fig. 4

9. CHANGE OF HINGE SIDE

- 1) Dismantle the top hinge. This one is to be used later as top hinge at the opposite side. Lift off the top door.



- 4) Adjusting the bottom door: Loosen the 3 screws in the bottom hinge and push the bottom hinge to the required side. Tighten the screws and mount the kick panel.

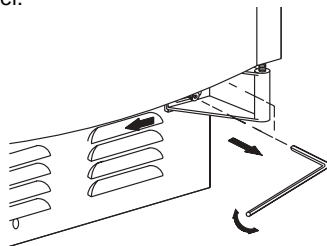

- 2) Remove the kick panel.

The bottom hinge is dismantled at the 3 screws. The hinge is turned 180° and mounted on the opposite side.

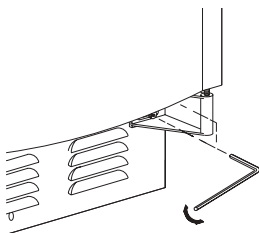

- 5) The kick panel is mounted.

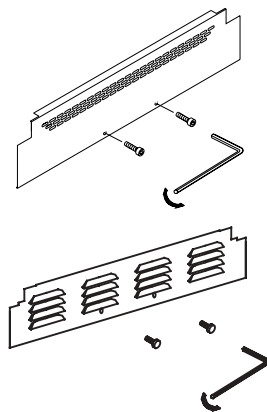

- 3) Adjustment of the top door: loosen the screws in the hinge above the door, loosen the hinge above the door and turn the hinge to the wanted side. Tighten the screws.

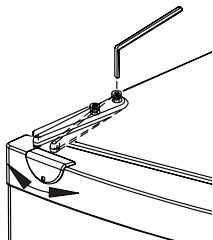

- 6) Move the handle.



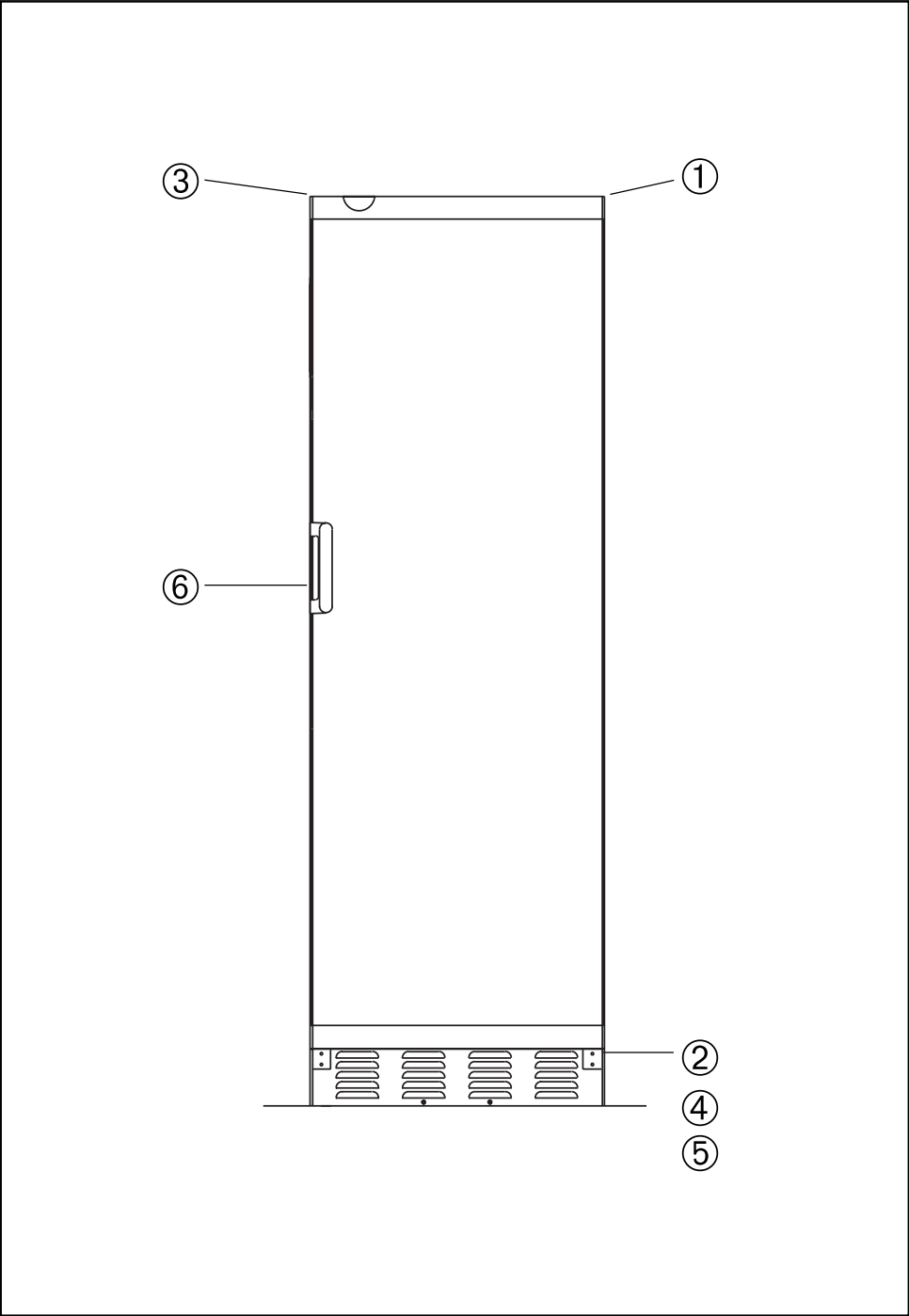



A large rectangular frame containing 20 horizontal lines, intended for writing.



A large rectangular frame containing 20 horizontal lines, providing a space for writing.

